

RELIGIOUS ARCHITECTURE

ISLAMIC DOMES

HINDU DOMES

SHIKHARS

SAMARANS



ARCHITECTURAL FIBERGLASS, INC.

8300 Bessemer Ave. * Cleveland, OH 44127-1839 * 216-641-8300 * Fax 216-641-8150 * www.fiberglass-afi.com

RA-501 (A-136)

HEIGHT: 5'-0"
WIDTH: 7'-3 1/8"

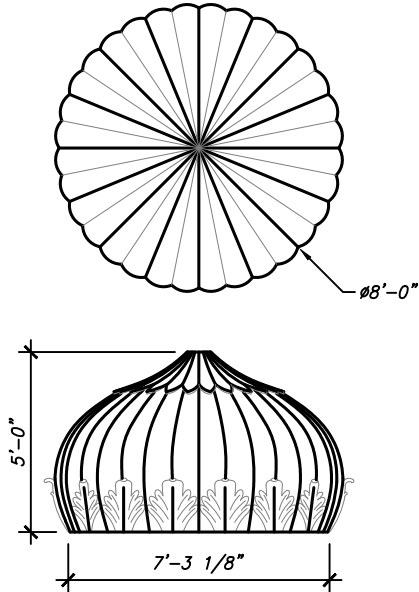

RA-502 (A-135)

HEIGHT: 6'-0"
WIDTH: 12'-0"

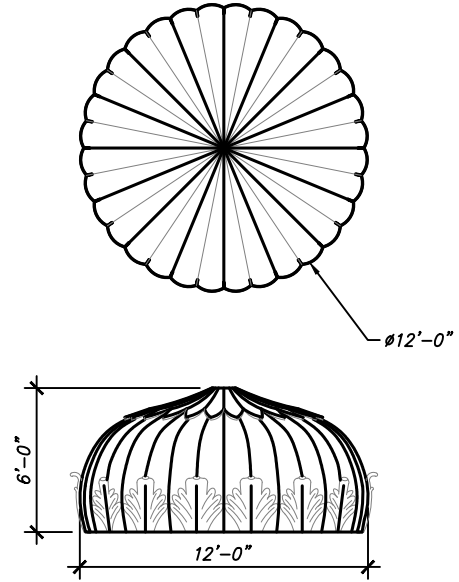

RA-503 (A-134)

HEIGHT: 9'-3"
WIDTH: 7'-0"

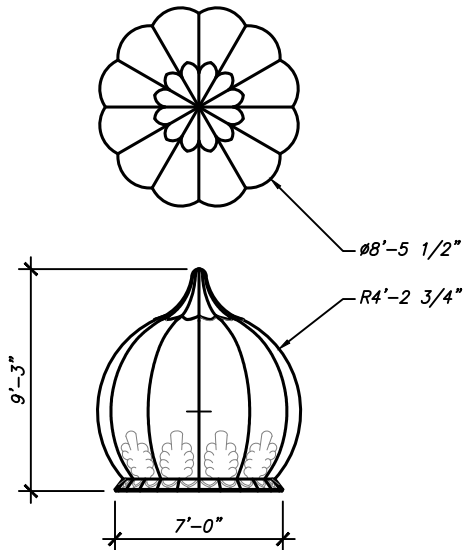

RA-504 (A-133)

HEIGHT: 21'-10 1/2"
WIDTH: 16'-6 1/2"

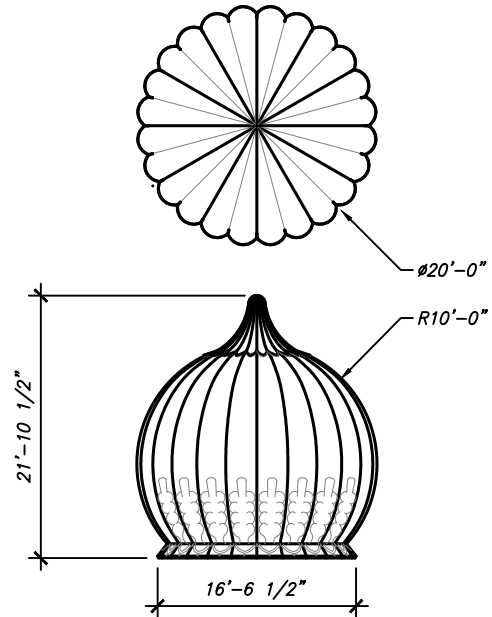

ARCHITECTURE

SHEET NO.

RA-01

2025

RELIGIOUS
ARCHITECTURE



ARCHITECTURAL FIBERGLASS, INC.

8300 BESSEMER AVE., CLEVELAND, OHIO 44127-1839
(216) 641-8300 - FAX:(216) 641-8150
www.fiberglass-afi.com

RA-505 (A-138)

HEIGHT: 3'-4 1/4"
WIDTH: 5'-9 3/4"

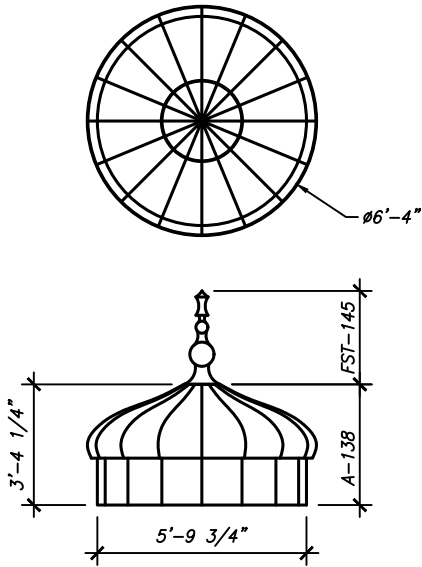

RA-506 (A-137)

HEIGHT: 6'-7 3/4"
WIDTH: 10'-8"

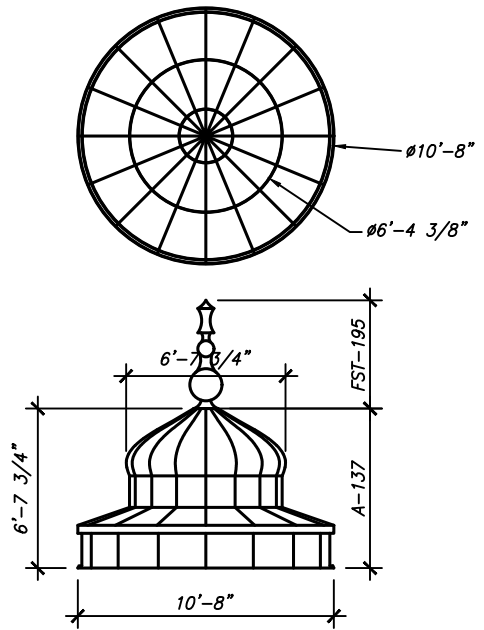

RA-507 (A-132)

HEIGHT: 4'-0"
WIDTH: 9'-0"

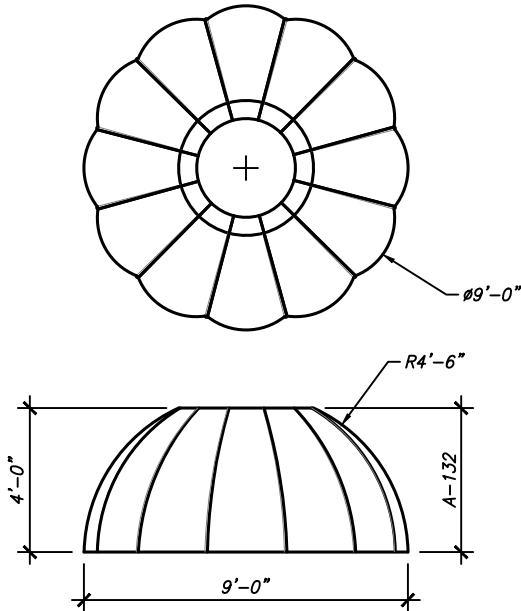

RA-508

HEIGHT: 11'-0"
WIDTH: 9'-4"

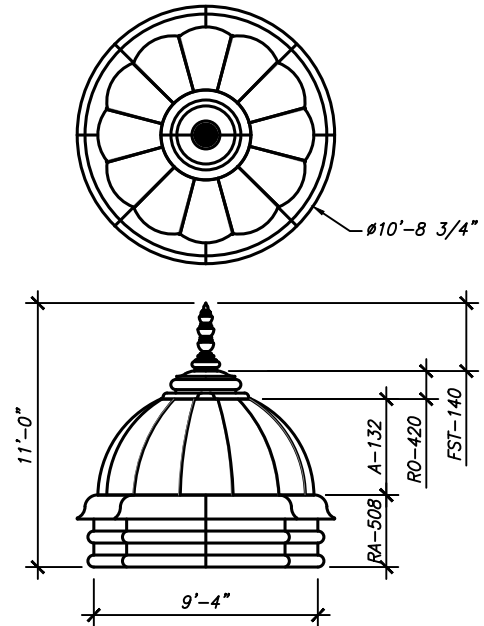

ARCHITECTURE

SHEET NO.

RA-02

2025

RELIGIOUS
ARCHITECTURE



ARCHITECTURAL FIBERGLASS, INC.

8300 BESSEMER AVE., CLEVELAND, OHIO 44127-1839
(216) 641-8300 - FAX:(216) 641-8150
www.fiberglass-afi.com

RA-509

HEIGHT: 10'-1"
WIDTH: 7'-8 3/4"

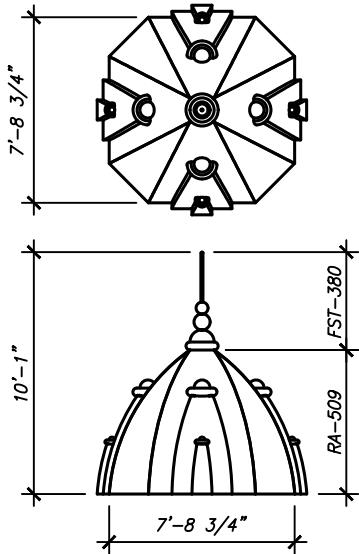

RA-510 (A-250)

HEIGHT: 9'-11 3/8"
WIDTH: 8'-0"

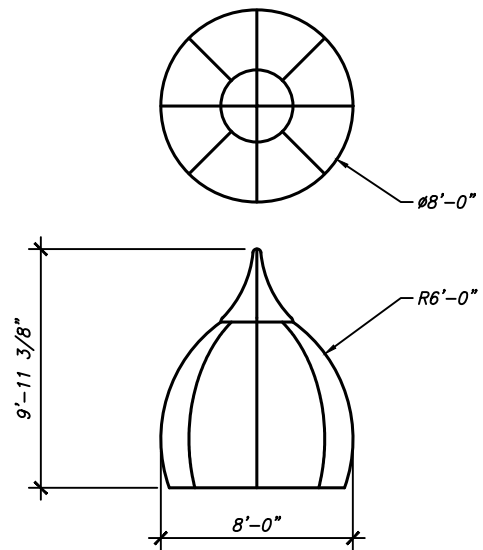

RA-511 (A-249)

HEIGHT: 13'-0 1/4"
WIDTH: 12'-0"

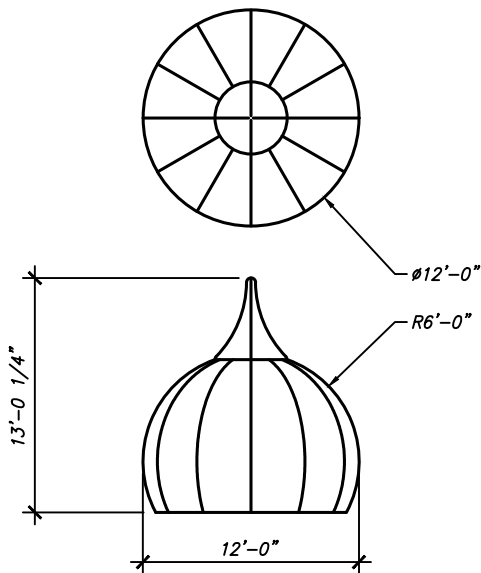

RA-512 (A-248)

HEIGHT: 9'-11"
WIDTH: 24'-0"

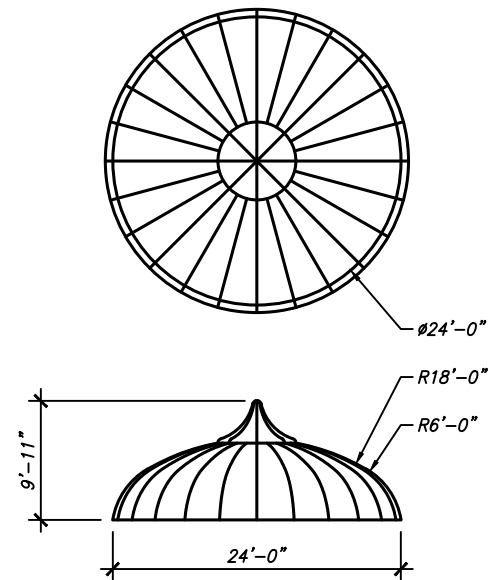

ARCHITECTURE

SHEET NO.

RA-03

2025

RELIGIOUS
ARCHITECTURE



ARCHITECTURAL FIBERGLASS, INC.

8300 BESSEMER AVE., CLEVELAND, OHIO 44127-1839
(216) 641-8300 - FAX:(216) 641-8150
www.fiberglass-afi.com

RA-513

HEIGHT: 25'-0"
WIDTH: 12'-0"

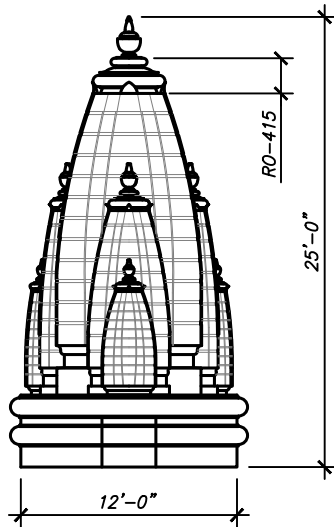

RA-514

HEIGHT: 31'-9"
WIDTH: 15'-4"
SQ.FT.: 3750.2

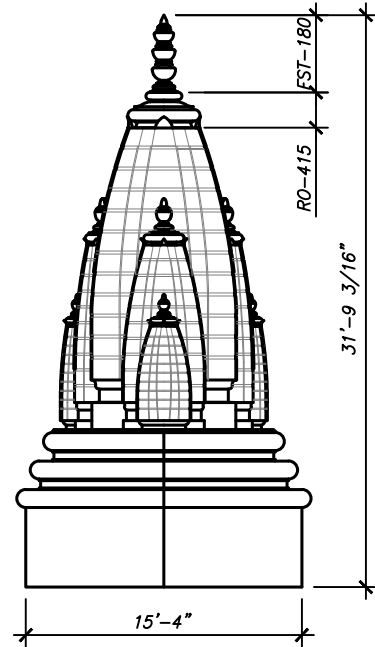

RA-515

HEIGHT: 27'-0"
WIDTH: 12'-0"

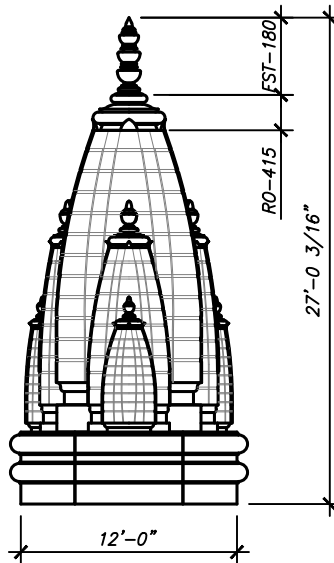

RA-516

HEIGHT: 24'-9"
WIDTH: 12'-4 1/2"

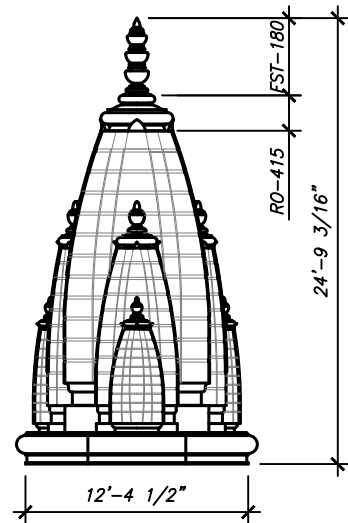

ARCHITECTURE

SHEET NO.

RA-04

2025

RELIGIOUS
ARCHITECTURE



ARCHITECTURAL FIBERGLASS, INC.

8300 BESSEMER AVE., CLEVELAND, OHIO 44127-1839
(216) 641-8300 - FAX:(216) 641-8150
www.fiberglass-afi.com

RA-517

HEIGHT: 52'-2 1/4"
WIDTH: 30'-5 1/2"

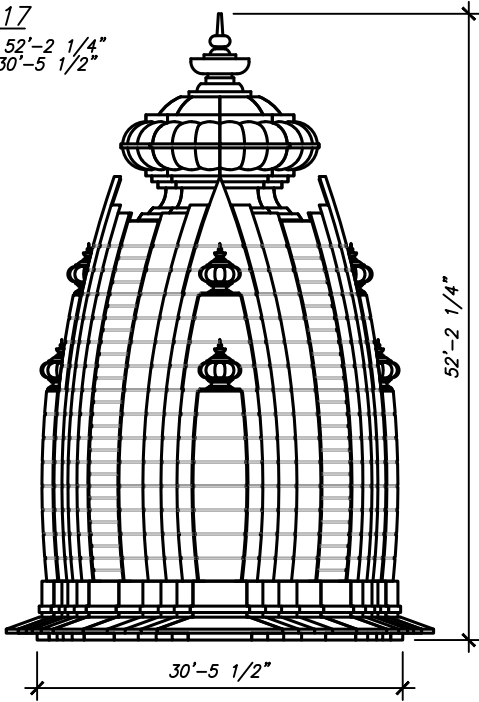

RA-518

HEIGHT: 25'-9 1/8"
WIDTH: 15'-3 1/2"

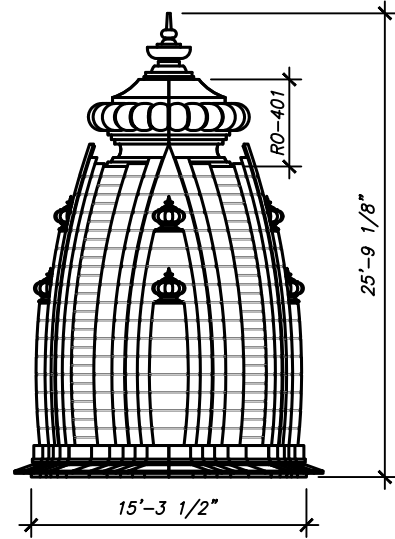

RA-519

HEIGHT: 23'-0 1/4"
WIDTH: 40'-1 1/2"

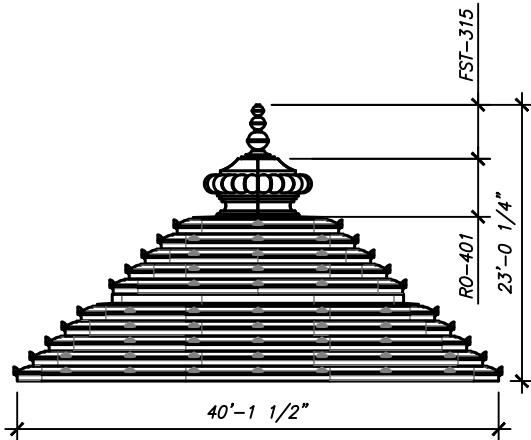

RA-520

HEIGHT: 14'-6 1/4"
WIDTH: 22'-3 1/2"

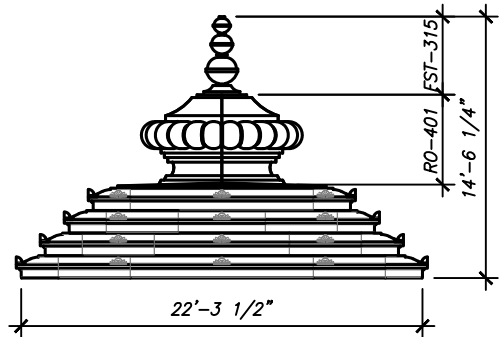

ARCHITECTURE

SHEET NO.

RA-05

2025

RELIGIOUS
ARCHITECTURE



ARCHITECTURAL FIBERGLASS, INC.

8300 BESSEMER AVE., CLEVELAND, OHIO 44127-1839
(216) 641-8300 - FAX:(216) 641-8150
www.fiberglass-afi.com

RA-521

HEIGHT: 9'-7 1/8"
WIDTH: 16'-10 7/8"

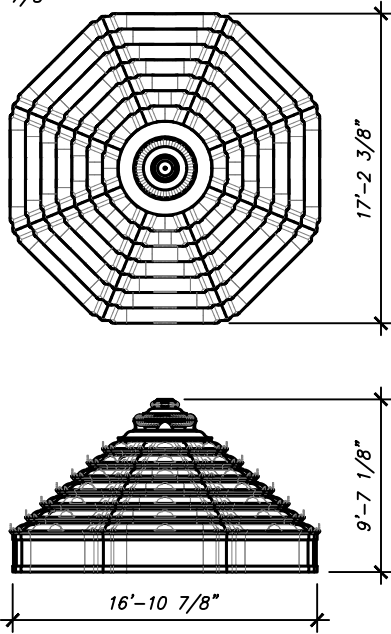

RA-522

HEIGHT: 6'-6 1/8"
WIDTH: 11'-10"

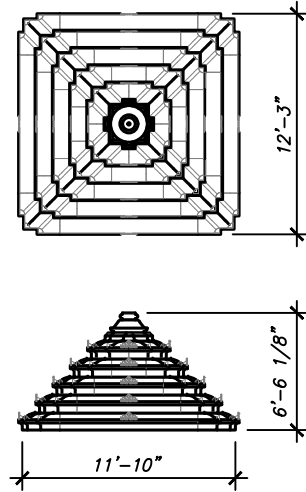

RA-523

HEIGHT: 6'-6 1/8"
WIDTH: 8'-0"

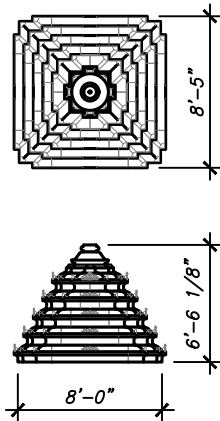

RA-524

HEIGHT: 21'-6 1/8"
WIDTH: 10'-8 1/2"

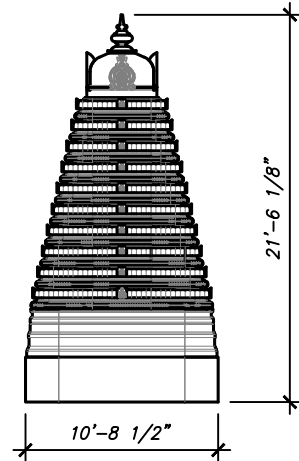

ARCHITECTURE

SHEET NO.

RA-06

2025

RELIGIOUS
ARCHITECTURE



ARCHITECTURAL FIBERGLASS, INC.

8300 BESSEMER AVE., CLEVELAND, OHIO 44127-1839
(216) 641-8300 - FAX:(216) 641-8150
www.fiberglass-afi.com

RA-525 (A-236)

HEIGHT: 5'-0"
WIDTH: 11'-7"

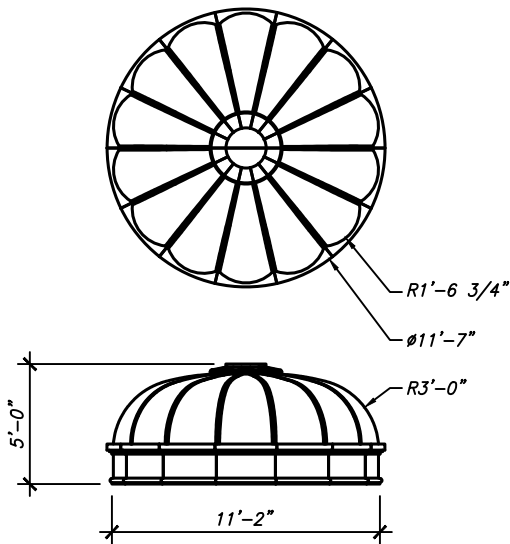

RA-526 (A-184)

HEIGHT: 17'-0"
WIDTH: 14'-0"

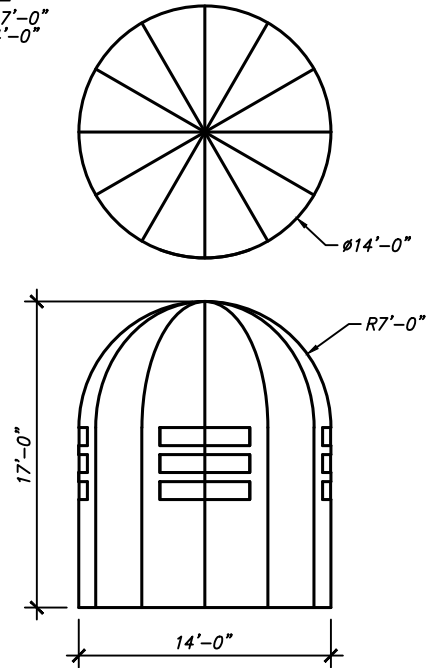

RA-527 (A-239)

HEIGHT: 9'-9"
WIDTH: 15'-0"

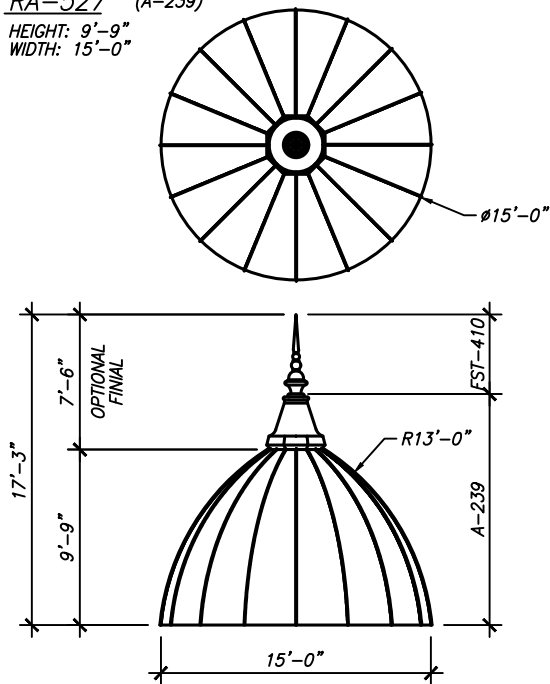

RA-528 (A-120)

HEIGHT: 15'-10"
WIDTH: 21'-11"

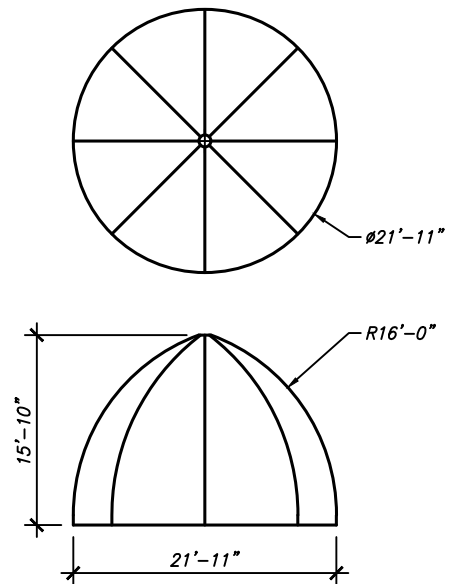

ARCHITECTURE

SHEET NO.

RA-07

2025

RELIGIOUS
ARCHITECTURE



ARCHITECTURAL FIBERGLASS, INC.

8300 BESSEMER AVE., CLEVELAND, OHIO 44127-1839
(216) 641-8300 - FAX:(216) 641-8150
www.fiberglass-afi.com

RA-529 (A-124)

HEIGHT: 1'-8"
WIDTH: 3'-4"

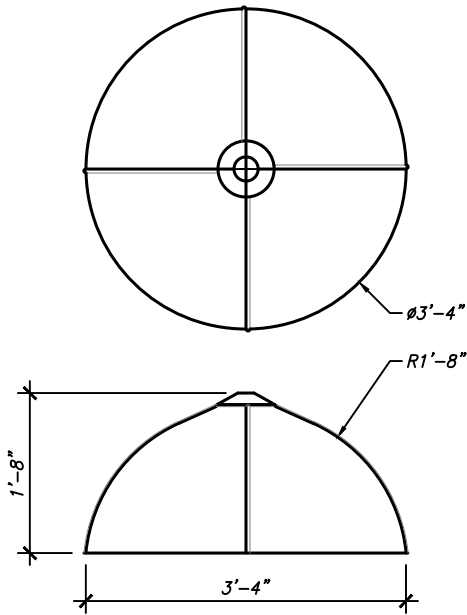

RA-530 (A-103)

HEIGHT: 3'-8 1/2"
WIDTH: 7'-0"

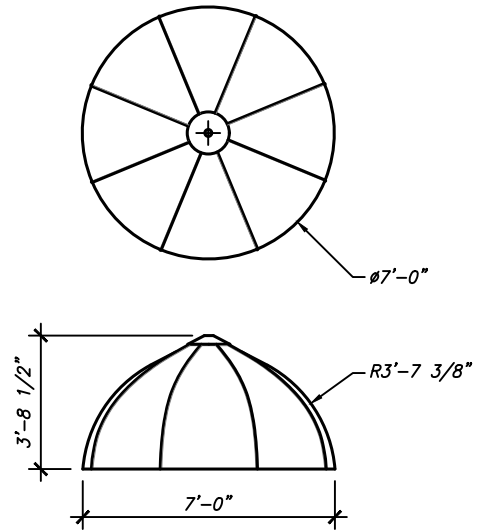

RA-531 (A-123)

HEIGHT: 4'-6"
WIDTH: 9'-0"

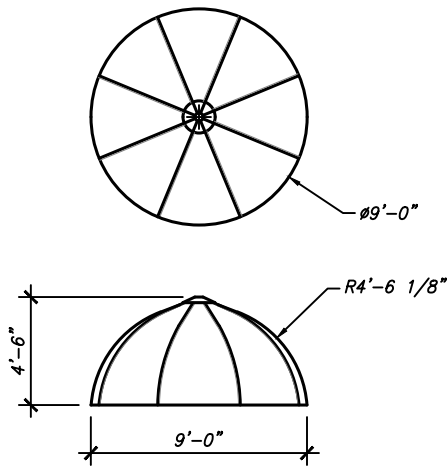

RA-532 (A-107)

HEIGHT: 6'-3"
WIDTH: 12'-0"

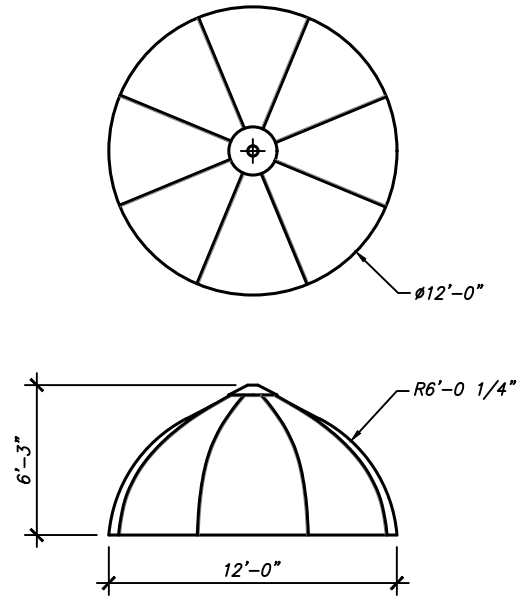

ARCHITECTURE

SHEET NO.

RA-08

2025

RELIGIOUS
ARCHITECTURE



ARCHITECTURAL FIBERGLASS, INC.

8300 BESSEMER AVE., CLEVELAND, OHIO 44127-1839
(216) 641-8300 - FAX:(216) 641-8150
www.fiberglass-afi.com

RA-533 (A-104)

HEIGHT: 7'-6 1/2"
WIDTH: 12'-0"

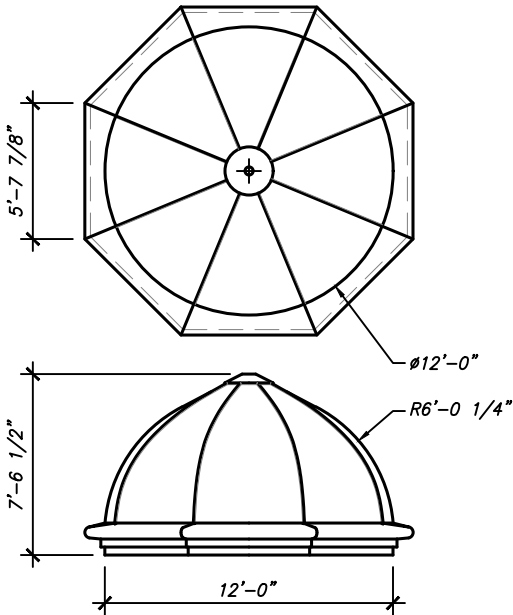

RA-534 (A-118)

HEIGHT: 4'-0"
WIDTH: 14'-0"

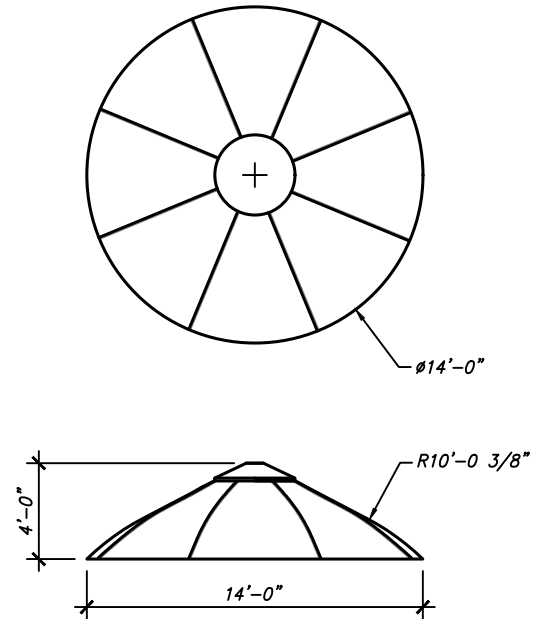

RA-535 (A-122)

HEIGHT: 10'-5"
WIDTH: 20'-0"

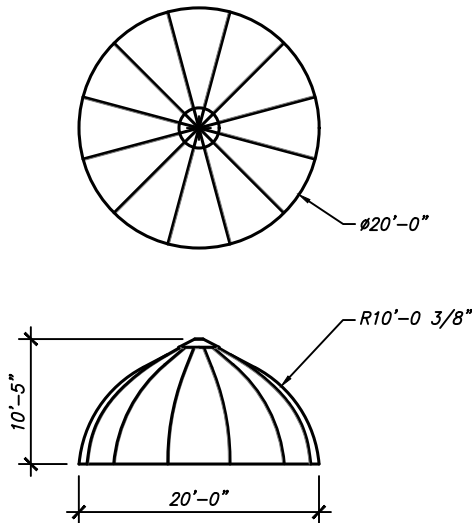

RA-536

HEIGHT: 6'-8"
WIDTH: 5'-6"

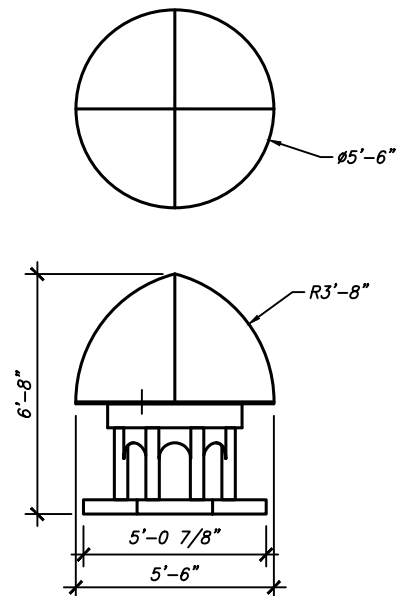

ARCHITECTURE

SHEET NO.

RA-09

2025

RELIGIOUS
ARCHITECTURE



ARCHITECTURAL FIBERGLASS, INC.

8300 BESSEMER AVE., CLEVELAND, OHIO 44127-1839
(216) 641-8300 - FAX:(216) 641-8150
www.fiberglass-afi.com

RA-537

HEIGHT: 18'-8 3/8"
WIDTH: 10'-1"

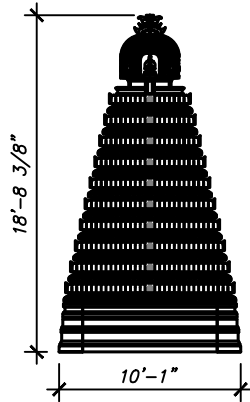

RA-538

HEIGHT: 3'-3 7/16"
WIDTH: 2'-4 1/2"

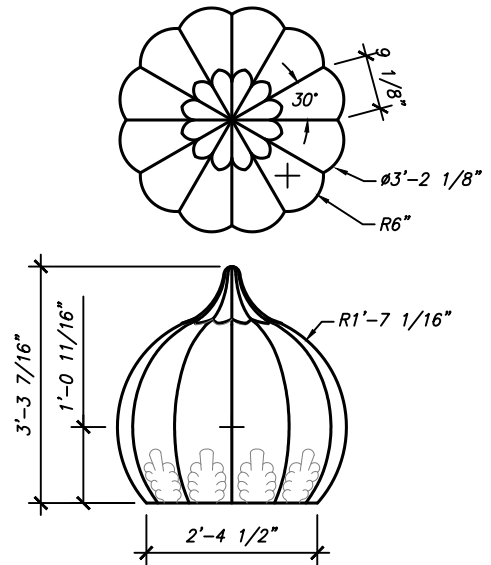

RA-539

HEIGHT: 12'-9"
WIDTH: 5'-0"

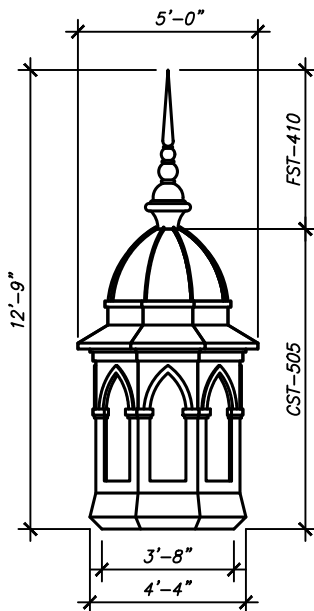

RA-540

HEIGHT: 6'-0"
WIDTH: 10'-5 1/8"

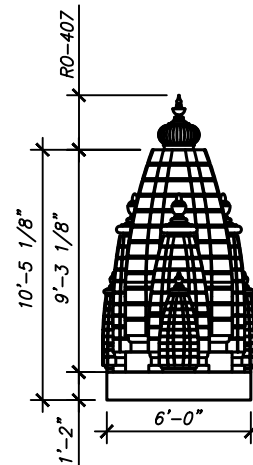

ARCHITECTURE

SHEET NO.

RA-10

2025

RELIGIOUS
ARCHITECTURE



ARCHITECTURAL FIBERGLASS, INC.

8300 BESSEMER AVE., CLEVELAND, OHIO 44127-1839
(216) 641-8300 - FAX:(216) 641-8150
www.fiberglass-afi.com